



■ Features :

- Universal AC input / Full range
- AC input active surge current limiting
- Built-in active PFC function, PF>0.96
- Protections: Short circuit / Overload / Over voltage / Over temperature
- Forced air cooling by built-in DC ball bearing fan
- High power density 5.48/inch³
- Built-in constant current limiting circuit
- With power good and fail signal output
- Built-in remote ON-OFF control
- Built-in remote sense function
- 3 years warranty



SPECIFICATION

MODEL	SP-750-5	SP-750-12	SP-750-15	SP-750-24	SP-750-27	SP-750-48	
OUTPUT	DC VOLTAGE	5V	12V	15V	24V	27V	48V
	RATED CURRENT	120A	62.5A	50A	31.3A	27.8A	15.7A
	CURRENT RANGE	0 ~ 120A	0 ~ 62.5A	0 ~ 50A	0 ~ 31.3A	0 ~ 27.8A	0 ~ 15.7A
	RATED POWER	600W	750W	750W	751.2W	750.6W	753.6W
	RIPPLE & NOISE (max.) Note.2	120mVp-p	120mVp-p	120mVp-p	120mVp-p	120mVp-p	120mVp-p
	VOLTAGE ADJ. RANGE	4.75 ~ 5.5V	10 ~ 13.5V	13.5 ~ 16.5V	22 ~ 26.4V	24 ~ 30V	43 ~ 56V
	VOLTAGE TOLERANCE Note.3	±2.0%	±1.0%	±1.0%	±1.0%	±1.0%	±1.0%
	LINE REGULATION	±0.5%	±0.3%	±0.3%	±0.2%	±0.2%	±0.2%
	LOAD REGULATION	±2.0%	±0.5%	±0.5%	±0.5%	±0.5%	±0.5%
	SETUP, RISE TIME	1500ms, 50ms/230VAC 1500ms, 50ms/115VAC at full load					
HOLD UP TIME (Typ.)	16ms/230VAC 16ms/115VAC at full load						
INPUT	VOLTAGE RANGE	90 ~ 264VAC 127 ~ 370VDC					
	FREQUENCY RANGE	47 ~ 63Hz					
	POWER FACTOR (Typ.)	PF>0.96/230VAC PF>0.99/115VAC at full load					
	EFFICIENCY (Typ.)	80%	85%	87%	89%	89%	90%
	AC CURRENT (Typ.)	8.8A/115VAC	4.2A/230VAC				
	INRUSH CURRENT (Typ.)	27A/115VAC	45A/230VAC				
	LEAKAGE CURRENT	<2.0mA / 240VAC					
PROTECTION	OVERLOAD	105 ~ 125% rated output power Protection type : Constant current limiting, unit will Hiccup after 3 sec.					
	OVER VOLTAGE	5.75 ~ 6.75V	13.8 ~ 16.2V	18 ~ 21V	27.6 ~ 32.4V	31 ~ 36.5V	57.6 ~ 67.2V
	OVER TEMPERATURE	85°C ±5°C (TSW1) detect on heatsink of power transistor 85°C ±5°C (TSW2) detect on heatsink of power diode Protection type : Shut down o/p voltage, recovers automatically after temperature goes down					
FUNCTION	POWER GOOD/FAIL	50ms/1ms					
	REMOTE CONTROL Note.5	RC+/RC- short power on, open power off					
ENVIRONMENT	WORKING TEMP.	-20 ~ +60°C (Refer to output load derating curve)					
	WORKING HUMIDITY	20~90% RH non-condensing					
	STORAGE TEMP., HUMIDITY	-40 ~ +85°C, 10 ~ 95% RH					
	TEMP. COEFFICIENT	±0.05%/°C (0 ~ 50°C)					
	VIBRATION	10 ~ 500Hz, 2G 10min./1cycle, 60min. each along X, Y, Z axes					
SAFETY & EMC (Note 4)	SAFETY STANDARDS	UL60950-1, TUV EN60950-1 approved					
	WITHSTAND VOLTAGE	I/P-O/P:3KVAC I/P-FG:1.5KVAC O/P-FG:0.5KVAC					
	ISOLATION RESISTANCE	I/P-O/P, I/P-FG, O/P-FG:100M Ohms/500VDC					
	EMI CONDUCTION & RADIATION	Compliance to EN55011 (CISPR11), EN55022 (CISPR22) Class B					
	HARMONIC CURRENT	Compliance to EN61000-3-2,-3					
	EMS IMMUNITY	Compliance to EN61000-4-2,3,4,5,6,8,11, ENV50204, EN55024, EN61000-6-2, EN61204-3, heavy industry level, criteria A					
OTHERS	MTBF	124K hrs min. MIL-HDBK-217F (25°C)					
	DIMENSION	278*127*63.5mm (L*W*H)					
	PACKING	2.9Kg; 6pcs / 18.4Kg / 0.98CUFT					
NOTE	<p>1. All parameters NOT specially mentioned are measured at 230VAC input, rated load and 25°C of ambient temperature.</p> <p>2. Ripple & noise are measured at 20MHz of bandwidth by using a 12" twisted pair-wire terminated with a 0.1uf & 47uf parallel capacitor.</p> <p>3. Tolerance : includes set up tolerance, line regulation and load regulation.</p> <p>4. The power supply is considered a component which will be installed into a final equipment. The final equipment must be re-confirmed that it still meets EMC directives.</p> <p>5. The power supply unit will have no output if the shorting connector is not assembled between RC+ & RC-.</p>						

Mechanical Specification

Case No.919A Unit:mm

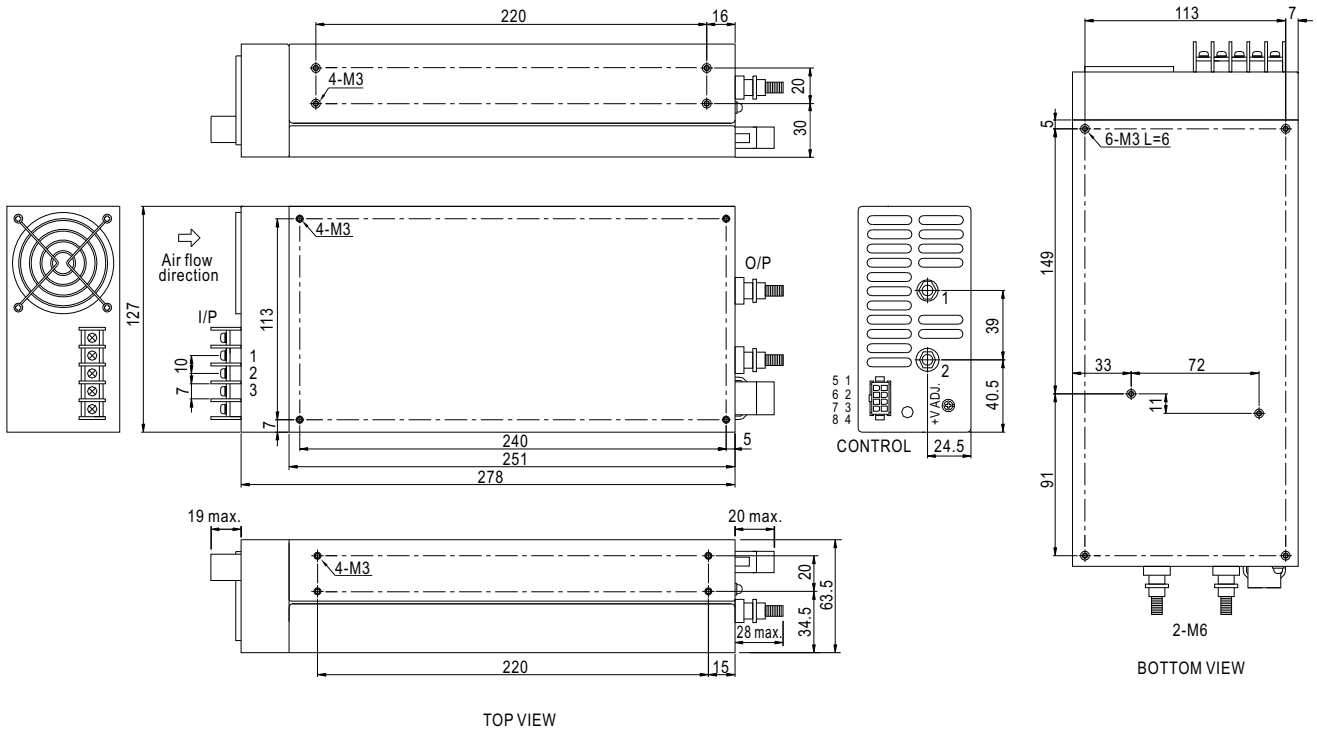

AC Input Terminal Pin No. Assignment

Pin No.	Assignment
1	AC/L
2	AC/N
3	FG \perp

DC Output Terminal Pin No. Assignment

Pin No.	Assignment
1	DC OUTPUT +V
2	DC OUTPUT -V

Control Pin No. Assignment : MOLEX 5559-NP uses 5558male crimp terminal

Pin No.	Assignment	Pin No.	Assignment	Mating connector	Terminal
1	NC	5	NC	MOLEX 5557-NR	MOLEX 5556 Female crimp Terminal receptacle
2	-S	6	PF(Power fail signal)		
3	G	7	+S		
4	RC-	8	RC+		

Block Diagram

PFC fosc : 100KHz
PWM fosc : 140KHz

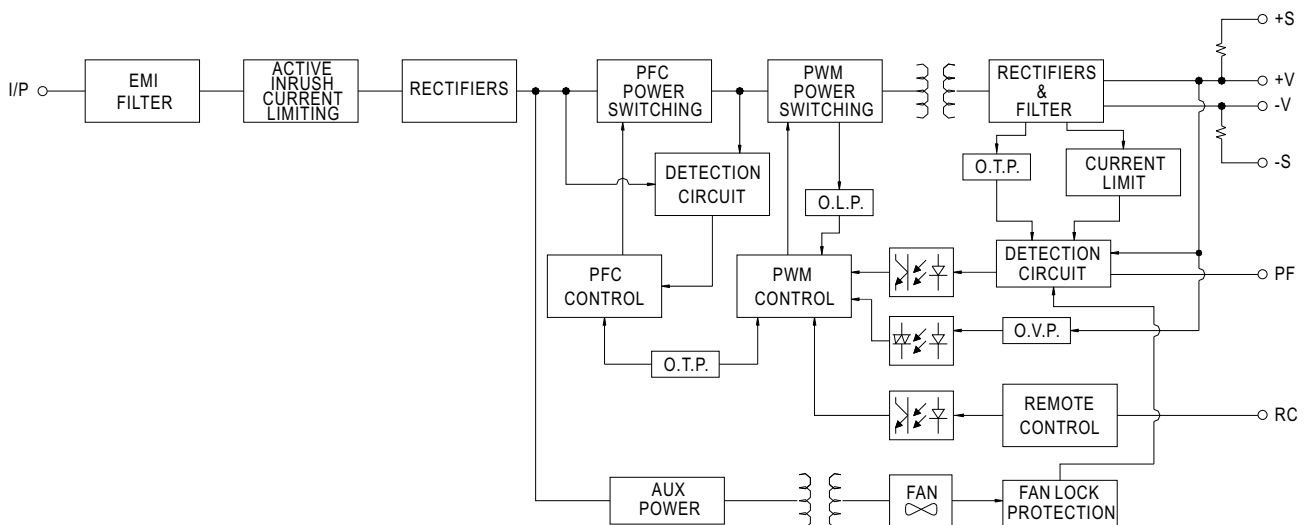

■ Derating Curve

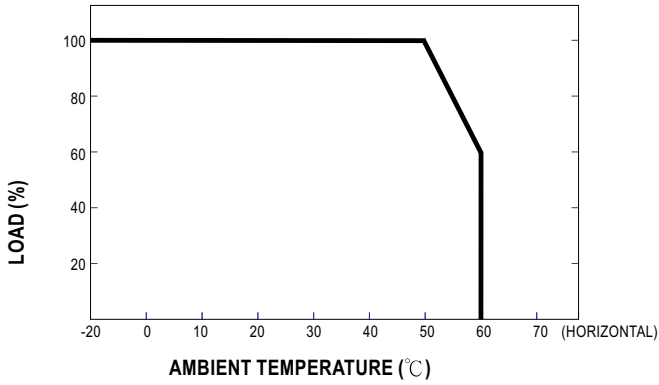

■ Static Characteristics

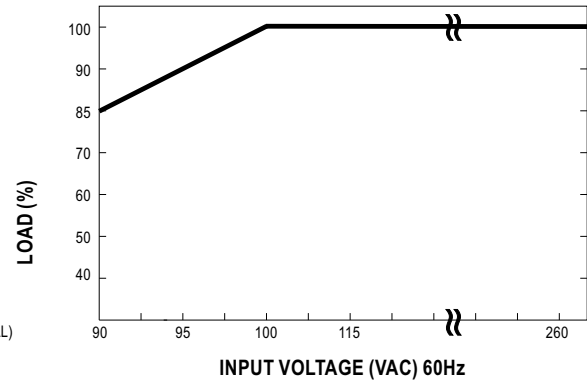

■ Control Terminal Instruction Manual

Power Fail Signal

PF Signal is the voltage difference between "G" and "PF" pin output

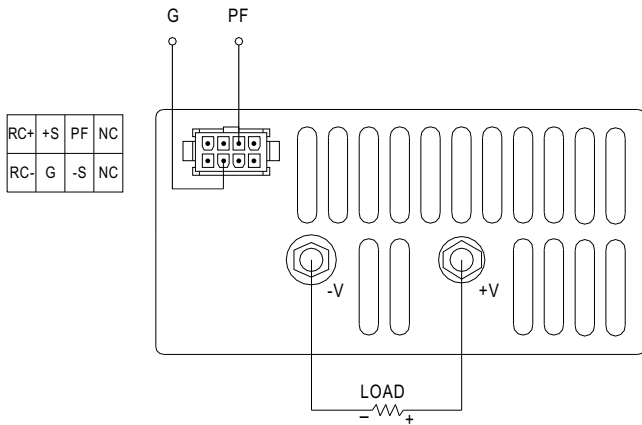

Remote Sensing

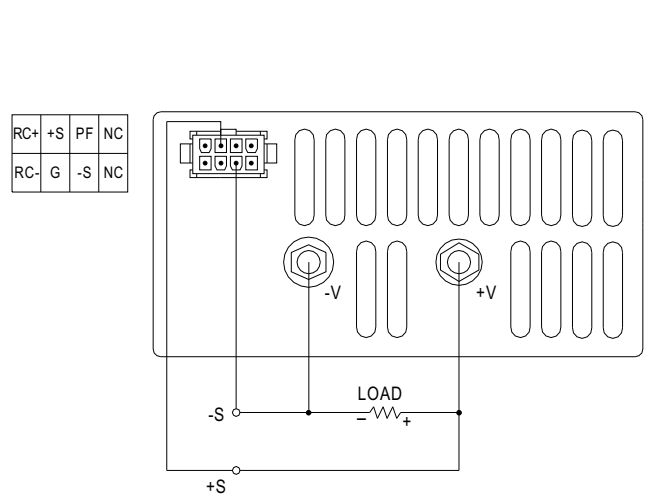

Remote Control

Power ON: RC+/RC- Short
Power OFF: RC+/RC- open

